

DESCRIPTION

The GLF1110 / GLF1111 is an ultra-efficiency, 2 A rated, Load Switch with integrated slew rate control. The best in class efficiency makes it an ideal choice for use in IoT, mobile, and wearable electronics.

The GLF1110 / GLF1111 features ultra-efficient I_QSmart™ technology that supports the lowest quiescent current (I_Q) and shutdown current (I_{SD}) in the industry. Low I_Q and I_{SD} solutions help designers to reduce parasitic leakage current, improve system efficiency, and increase battery lifetime.

The integrated slew rate control can also enhance system reliability by mitigating bus voltage swings during switching events. Where uncontrolled switches can generate high inrush currents that result in voltage droop and/or bus reset events, the GLF slew rate control specifically limits inrush currents during turn-on to minimize voltage droop.

The GLF1110 / GLF1111 supports an industry leading wide input voltage range and helps to improve operating life and system robustness. Furthermore, one device can be used in multiple voltage rail applications which helps to simplify inventory management and reduce operating cost.

FEATURES

- Wide Input Range: 1.5 V to 5.5 V
6 V abs max
- R_{ON} : 54 mΩ Typ @ 5.5 V_{IN}
- I_{OUT} Max: 2 A
- Ultra-Low I_Q: 2 nA Typ @ 5.5 V_{IN}
- Ultra-Low I_{SD}: 13 nA Typ @ 5.5 V_{IN}
- Controlled Rise Time: 600 μs at 3.3 V_{IN}
- Internal EN Pull-Down Resistor
- Integrated Output Discharge Switch: GLF1111
- Wide Operating Temperature Range:
-40 °C ~ 85 °C
- HBM: 4 kV, CDM: 2 kV

APPLICATIONS

- Telecommunication Module
- Low Power Subsystem
- Mobile Devices

PACKAGE

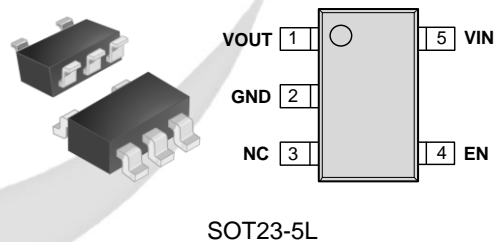

APPLICATION DIAGRAM

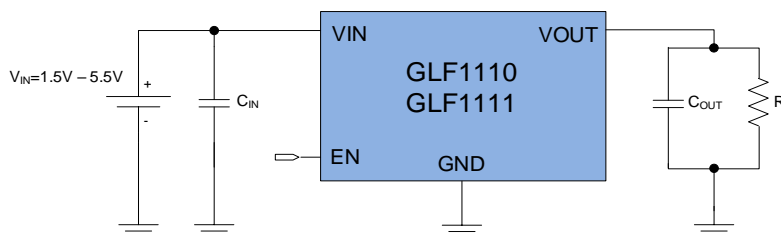

ALTERNATE DEVICE OPTIONS

Part Number	Top Mark	R _{ON} (Typ) at 5.5 V	Output Discharge	EN Activity
GLF1110-T1G7	DK	54 mΩ	NA	High
GLF1111-T1G7	DL	54 mΩ	85 Ω	High

FUNCTIONAL BLOCK DIAGRAM

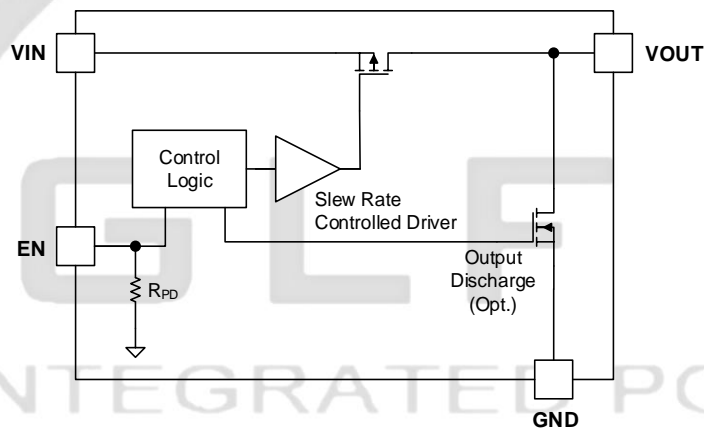

Figure 1. Functional Block Diagram

PIN CONFIGURATION

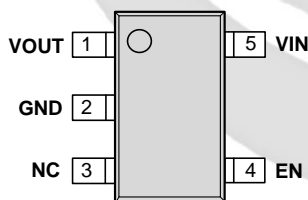

Figure 2. SOT23-5L

PIN DEFINITION

Pin #	Name	Description
1	V _{OUT}	Switch Output
2	GND	Ground
3	NC	No connection
4	EN	Enable to control the switch
5	V _{IN}	Switch Input. Supply Voltage for IC

ABSOLUTE MAXIMUM RATINGS

Stresses exceeding the absolute maximum ratings may damage the device. The device may not function or be operable above the recommended operating conditions; extended exposure to stresses above the recommended operating conditions may affect device reliability. The absolute maximum ratings are stress ratings only.

Symbol	Parameter	Min.	Max.	Unit
V _{IN}	V _{IN} , V _{OUT} , V _{EN} to GND	-0.3	6	V
I _{OUT}	Maximum Continuous Switch Current		2	A
P _D	Power Dissipation at T _A = 25 °C		1.0	W
T _{STG}	Storage Junction Temperature	-65	150	°C
T _A	Operating Temperature Range	-40	85	°C
θ _{JC}	Thermal Resistance, Junction to Case		90	°C/W
θ _{JA}	Thermal Resistance, Junction to Ambient		180	°C/W
ESD	Electrostatic Discharge Capability	Human Body Model, JESD22-A114	4	kV
		Charged Device Model, JESD22-C101	2	

RECOMMENDED OPERATING CONDITIONS

Symbol	Parameter	Min.	Max.	Unit
V _{IN}	Supply Voltage	1.5	5.5	V
T _A	Ambient Operating Temperature	-40	+85	°C

ELECTRICAL CHARACTERISTICS

Values are at V_{IN} = 3.3 V and T_A = 25 °C unless otherwise noted.

Symbol	Parameter	Conditions	Min.	Typ.	Max.	Units
Basic Operation						
V _{IN}	Supply Voltage		1.5		5.5	V
I _Q	Quiescent Current ⁽¹⁾	EN = Enable, I _{OUT} =0 mA, V _{IN} = V _{EN} =5.5V		2		nA
		EN=Enable, I _{OUT} =0 mA, V _{IN} =V _{EN} =5.5V, T _a =85°C ⁽⁴⁾		8.5		
I _{SD}	Shut Down Current	EN = Disable, I _{OUT} =0 mA, V _{IN} =1.5 V		2		nA
		EN = Disable, I _{OUT} =0 mA, V _{IN} =3.3 V		3		
		EN = Disable, I _{OUT} =0 mA, V _{IN} =4.5 V		5		
		EN = Disable, I _{OUT} =0 mA, V _{IN} =5.5 V		13		
		EN = Disable, I _{OUT} =0 mA, V _{IN} =5.5 V, T _a =85 °C ⁽⁴⁾		280		
R _{ON}	On-Resistance	V _{IN} =5.5 V, I _{OUT} = 500 mA	T _a =25 °C	54		mΩ
			T _a =85 °C ⁽⁴⁾	63		
		V _{IN} =3.3 V, I _{OUT} = 500 mA	T _a =25 °C	64		
			T _a =85 °C ⁽⁴⁾	75		
V _{IN} =1.5 V, I _{OUT} = 100 mA	T _a =25 °C	116				
R _{DSC}	Output Discharge Resistance	V _{EN} =LOW, I _{FORCE} = 10 mA, GLF1111		85		Ω
V _{IH}	EN Input Logic High Voltage	V _{IN} =1.5 V – 1.8 V	0.9			V
		V _{IN} =1.8 V - 5.5 V	1.2			V
V _{IL}	EN Input Logic Low Voltage	V _{IN} =1.5 V – 1.8 V			0.3	V
		V _{IN} =1.8 V - 5.5 V			0.4	V

R _{EN}	EN pull down resistance	Internal Resistance		10		MΩ
I _{EN}	EN Current	V _{EN} =5.5 V		0.5		μA
Switching Characteristics (2, 3)						
t _{dON}	Turn-On Delay	R _L =150 Ω, C _{OUT} =0.1 μF		450		μs
t _r	V _{OUT} Rise Time			600		
t _{dOFF}	Turn-Off Delay (4)	R _L =150 Ω, C _{OUT} =0.1 μF : GLF1110		17		μs
t _f	V _{OUT} Fall Time (4)			32		
t _{dOFF}	Turn-Off Delay (4)	R _L =150 Ω, C _{OUT} =0.1 μF : GLF1111		17		
t _f	V _{OUT} Fall Time (4)			12		

- Notes:
1. I_Q does NOT include Enable pull down current through the pull-down resistor R_{PD}.
 2. t_{ON} = t_{dON} + t_r, t_{OFF} = t_{dOFF} + t_f
 3. Output discharge path is enabled during off.
 4. By design; characterized, not production tested

TIMING DIAGRAM

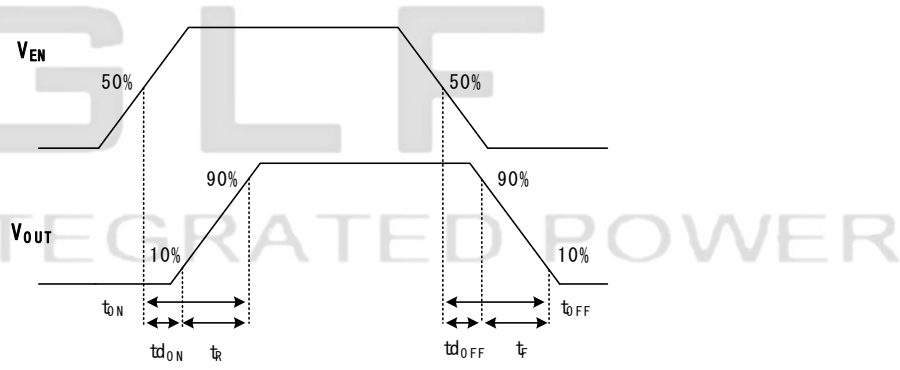

Figure 3. Timing Diagram

TYPICAL PERFORMANCE CHARACTERISTICS

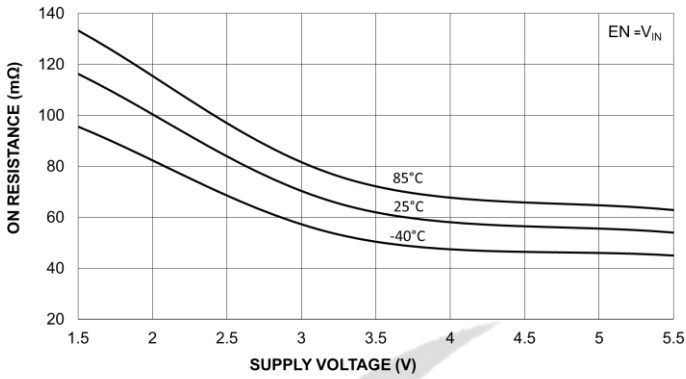

Figure 4. On-Resistance vs. Supply Voltage

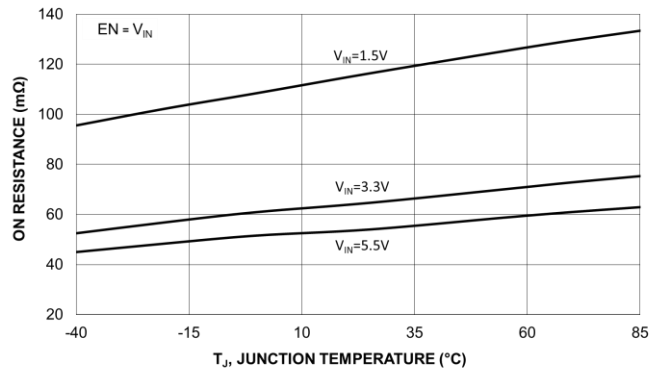

Figure 5. On-Resistance vs. Temperature

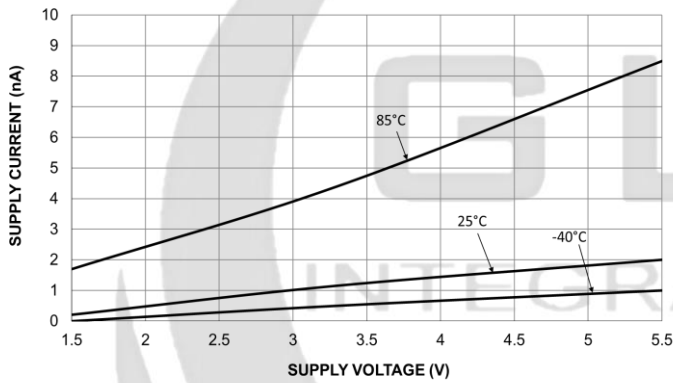

Figure 6. Quiescent Current vs. Supply Voltage

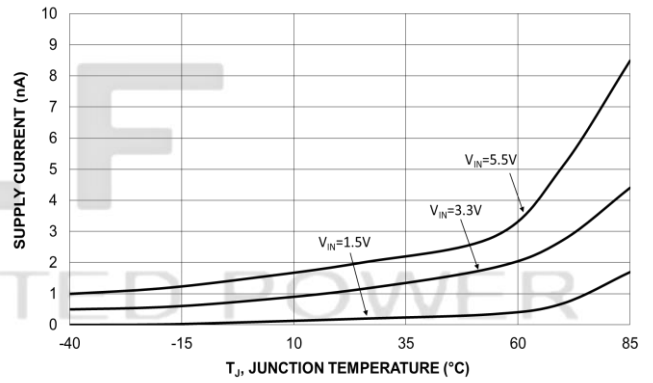

Figure 7. Quiescent Current vs. Temperature

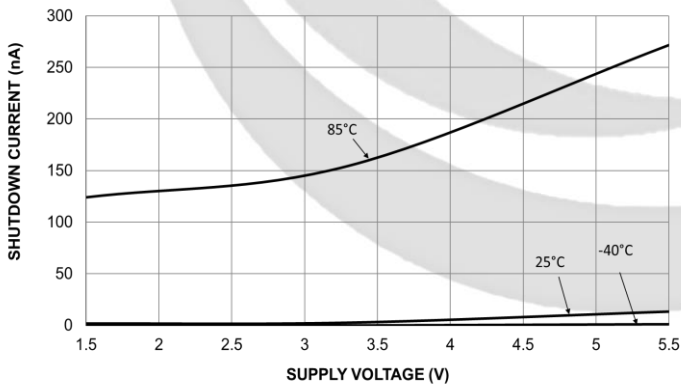

Figure 8. Shutdown Current vs. Input Voltage

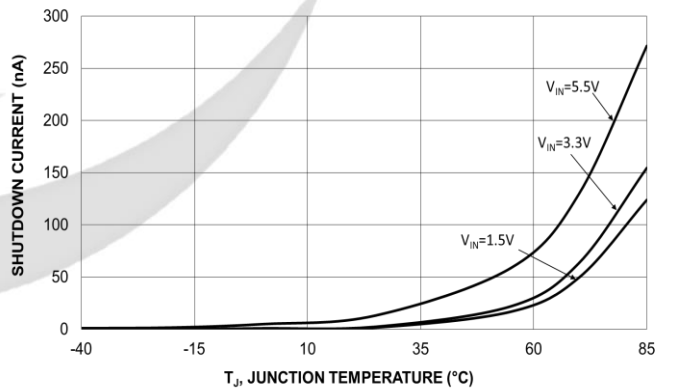

Figure 9. Shutdown Current vs. Temperature

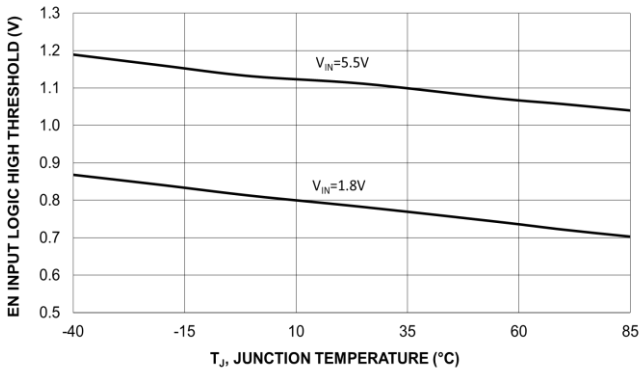

Figure 10. EN Input Logic High Threshold Vs. Temperature

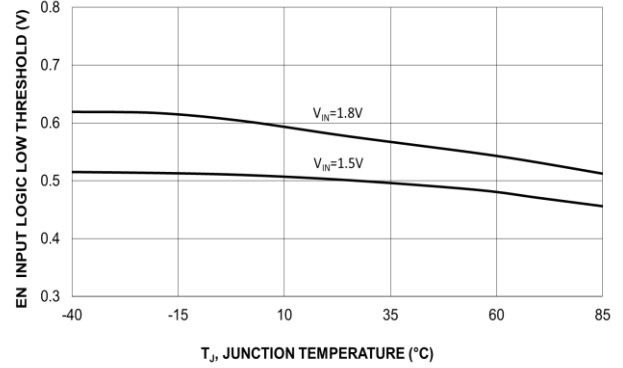

Figure 11. EN Input Logic Low Threshold Vs. Temperature

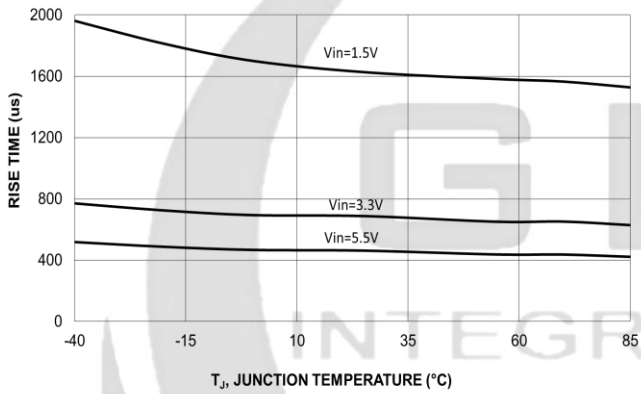

Figure 12. V_{OUT} Rise Time vs. Temperature

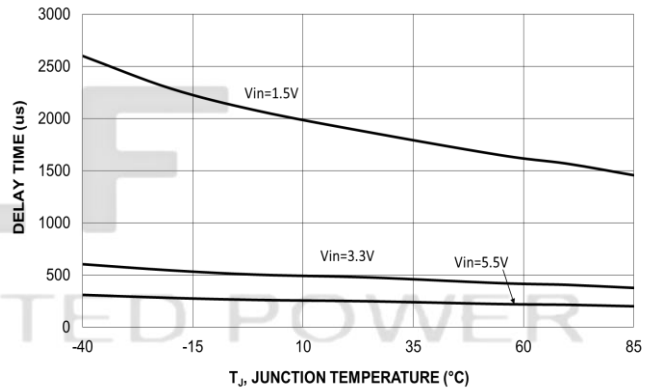

Figure 13. Turn-On Delay Time vs. Temperature

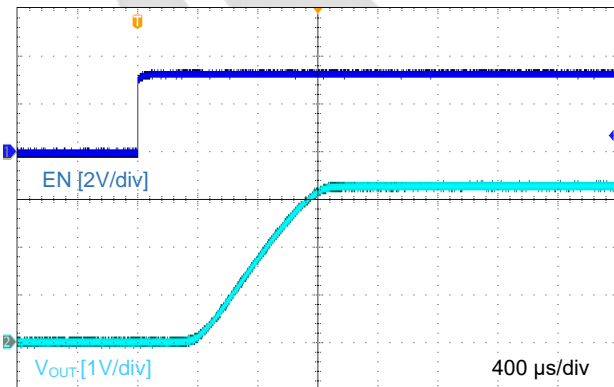

Figure 14. Turn-On Response, GLF1110
 $V_{IN}=3.3\text{ V}$, $C_{IN}=0.1\text{ }\mu\text{F}$, $C_{OUT}=0.1\text{ }\mu\text{F}$, $R_L=150\text{ }\Omega$

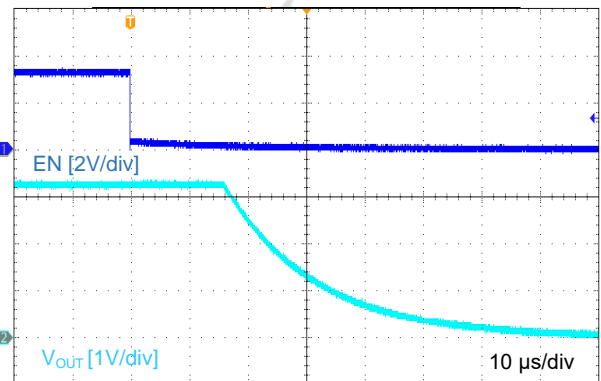

Figure 15. Turn-Off Response, GLF1110
 $V_{IN}=3.3\text{ V}$, $C_{IN}=0.1\text{ }\mu\text{F}$, $C_{OUT}=0.1\text{ }\mu\text{F}$, $R_L=150\text{ }\Omega$

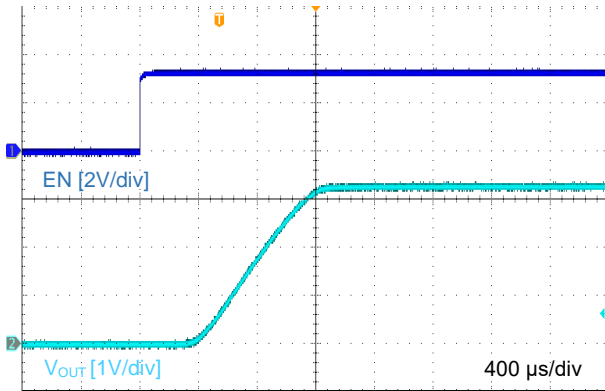

Figure 16. Turn-On Response, GLF1111
 $V_{IN}=3.3\text{ V}$, $C_{IN}=0.1\text{ }\mu\text{F}$, $C_{OUT}=0.1\text{ }\mu\text{F}$, $R_L=150\text{ }\Omega$

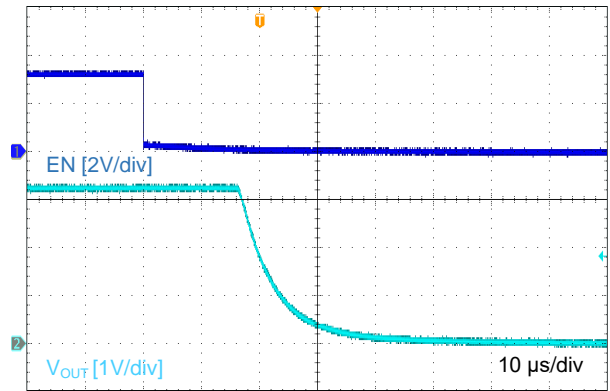

Figure 17. Turn-Off Response, GLF1111
 $V_{IN}=3.3\text{ V}$, $C_{IN}=0.1\text{ }\mu\text{F}$, $C_{OUT}=0.1\text{ }\mu\text{F}$, $R_L=150\text{ }\Omega$

APPLICATION INFORMATION

The GLF1110 / GLF1111 is an integrated 2 A, Ultra-Efficient I_QSmart™ Load Switch devices with a fixed slew rate control to limit the inrush current during turn on. Each device is capable of operating over a wide input range from 1.5 V to 5.5 V with very low on-resistance to reduce conduction loss. In the off state, these devices consume very low leakage current to avoid unwanted standby current and save limited input power.

Input Capacitor

The GLF1110 / GLF1111 does not require an input capacitor. However, to reduce the voltage drop on the input power rail caused by transient inrush current at start-up, a 0.1 μF capacitor is recommended to be placed close to the V_{IN} pin. A higher input capacitor value can be used to further attenuate the input voltage drop.

Output Capacitor

The GLF1110 / GLF1111 does not require an output capacitor. However, use of an output capacitor is recommended to mitigate voltage undershoot on the output pin when the switch is turning off. Undershoot can be caused by parasitic inductance from board traces or intentional load inductances. If load inductances do exist, use of an output capacitor can improve output voltage stability and system reliability. The C_{OUT} capacitor should be spaced close to the V_{OUT} and GND pins.

EN pin

The GLF1110 / GLF1111 can be activated by forcing EN pin high level. Note that the EN pin has an internal pull-down resistor to help pull the main switch to a known “off state” when no EN signal is applied from an external controller.

Output Discharge Function

The GLF1111 has an internal discharge N-channel FET switch on the V_{OUT} pin. When EN signal turns the main power FET to an off state, the N-channel switch turns on to discharge an output capacitor quickly.

Board Layout

All traces should be as short as possible to minimize parasitic inductance effects. Wide traces for V_{IN} , V_{OUT} , and GND will help reduce signal degradation and parasitic effects during dynamic operation as well as improve the thermal performance at high load current.

PACKAGE OUTLINE

Size Mark	Min (mm)	Max (mm)	Size Mark	Min (mm)	Max (mm)
A	2.82	3.02	C	1.05	1.15
e	0.95 (BSC)		C1	0.03	0.15
b	0.28	0.45	C2	0.12	0.23
B	1.50	1.70	L	0.35	0.55
B1	2.60	3.00	θ	0°	8°

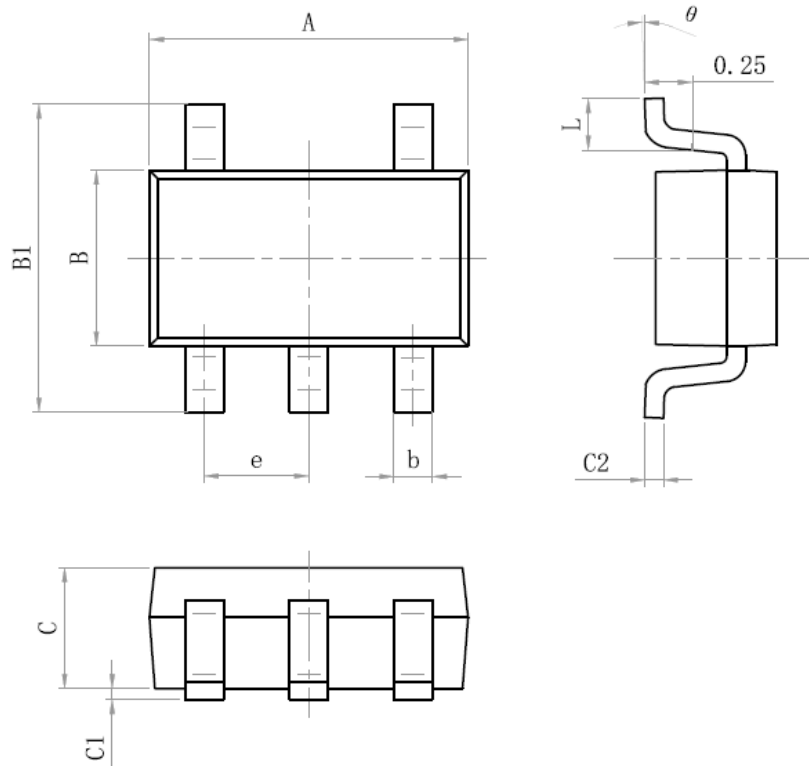

VER

Recommended Footprint

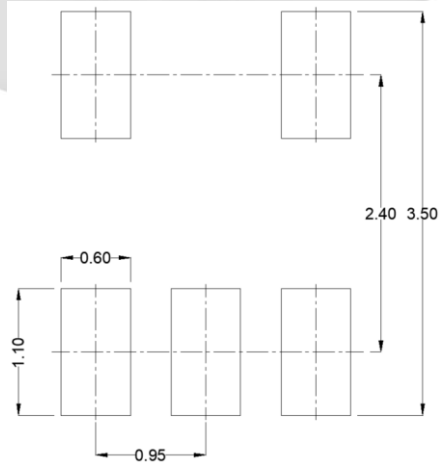

TAPE AND REEL INFORMATION

REEL DIMENSIONS

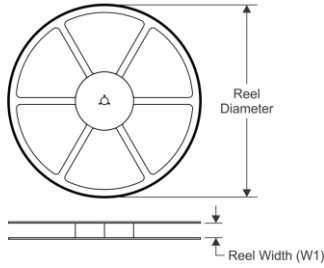

QUADRANT ASSIGNMENTS PIN 1 ORIENTATION TAPE

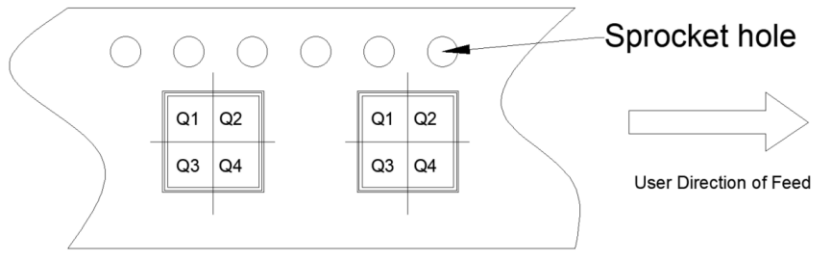

TAPE DIMENSIONS

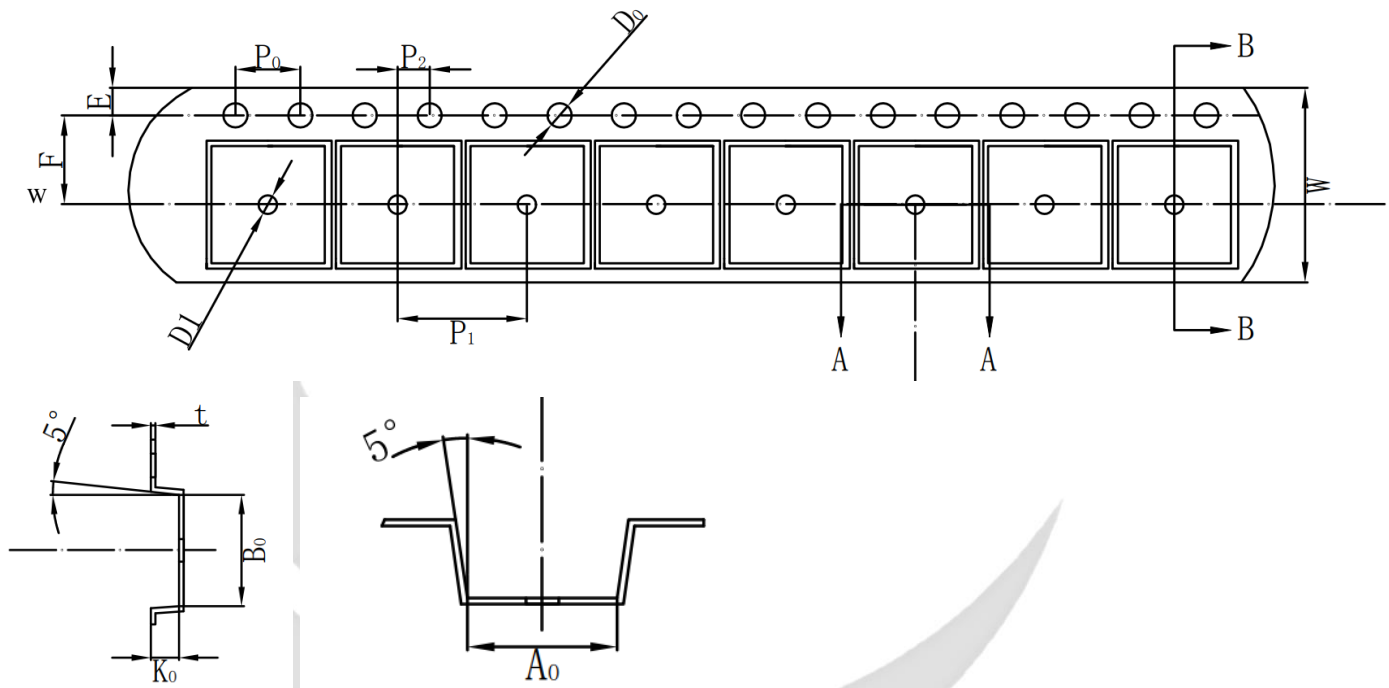

Device	Package	Pins	SPQ	Reel Diameter(mm)	Reel Width W1	A0	B0	K0	P1	W	Pin1
GLF1110-T1G7	SOT23-5	5	3000	178	9	3.25	3.30	1.38	4	8	Q3
GLF1111-T1G7	SOT23-5	5	3000	178	9	3.25	3.30	1.38	4	8	Q3

Remark:

- A0: Dimension designed to accommodate the component width
- B0: Dimension designed to accommodate the component length
- C0: Dimension designed to accommodate the component thickness
- W: Overall width of the carrier tape
- P1: Pitch between successive cavity centers

SPECIFICATION DEFINITIONS

Document Type	Meaning	Product Status
Target Specification	This is a target specification intended to support exploration and discussion of critical needs for a proposed or target device. Spec limits including typical, minimum, and maximum values are desired, or target, limits. GLF reserves the right to change limits at any time without warning or notification. A target specification in no way guarantees future production of the device in question.	Design / Development
Preliminary Specification	This is a draft version of a product specification. The specification is still under internal review and subject to change. GLF reserves the right to change the specification at any time without warning or notification. A preliminary specification in no way guarantees future production of the device in question.	Qualification
Product Specification	This document represents the anticipated production performance characteristics of the device.	Production

DISCLAIMERS

Information in this document is believed to be accurate and reliable, however GLF assumes no liability for errors or omissions. Device performance may be impacted by testing methods and application use cases. Users are responsible to independently evaluate the applicability, usability, and suitability of GLF devices in their application. In no case will GLF be liable for incidental, indirect, or consequential damages associated with the use, mis-use, or sale of its product. Customers are wholly responsible to assure GLF devices meet their system level and end product requirements. GLF retains the right to change the information provided in this data sheet without notice.